



THE COVER COMPANY, INC.

COVERLON SAFETY POOL COVER

OWNER'S MANUAL

INSTALLATION GUIDE - CARE & MAINTENANCE - WARRANTY INFORMATION

Thank you for purchasing a COVERLON safety pool cover. Your new cover (when installed correctly) will meet and exceed the ASTM safety standards. Please take the time to read all of the paperwork, because misuse can result in serious injury or death! With the proper amount of maintenance, you will get the longest life out of your cover.

COVERLON INSTALLATION GUIDE

Rectangular Cover Installation

1. Measure the cover and the pool, then lay the cover across the pool and adjust for equal overlap. Rectangular covers will have approximately 12" overlap on all sides. Example: 20' x 40' pool size is 22' x 42' cover size.

2. Measure back 18" - 21" from edge of the cover (NOT the pool edge) at 90 degrees right angles to the cover edge to position your 8 corner anchors. Instead of going out exactly 90 degrees, angle approximately 1" away from the center to allow for eventual cover stretch and to decrease wrinkles.

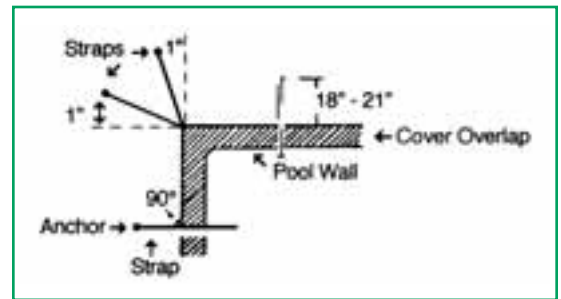

3. Attach the springs to the cover straps, then attach the springs onto the anchors using an installation rod. **NOTE:** Springs must be approximately 90% compressed for a proper drum tight fit.

4. Snap a chalk line along the perimeter of the pool, using the corner anchors as a guide. This will insure all anchors are properly aligned and of equal distance from the side of the pool.

5. With all 4 corners now secured, align and secure the remaining springs and anchors using the chalk line as a guide. When the springs and anchors are installed, re-adjust the springs so there is equal tension on all parts of the cover and the cover is straight.

Form Fit Cover Installation

1. Lay the cover across the pool and adjust for equal overlap on all sides. **NOTE:** Form Fit covers will have approximately 15" - 18" overlap depending on the size of the cover.

2. Locate and mark the first 8 anchor positions (see Drawing). There will be 2 anchors on each side of the length and 2 anchors on each side of the width.

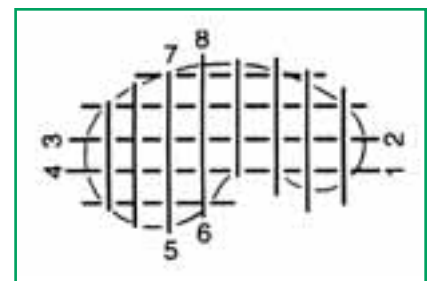

3. Attach the springs to the cover straps, then attach the springs onto the anchors using an installation tool. **NOTE:** Springs must be approximately 90% compressed for the proper drum tight fit.

4. With the first 8 anchors now secured, locate and install the remaining anchors. **NOTE:** It is best to use an alternating pattern working out from the middle of the cover to its ends. This method will ensure a nice even fit with straight lines and no wrinkles.

5. Re-adjust the springs so that there is equal tension on all parts of the cover and the cover lies flat with no creases or wrinkles.

ANCHOR INSTALLATION

Anchor Installation In Concrete

You will need to drill holes in the concrete to accommodate our brass anchoring system.

1. Mark anchor positions and drill a 3/4" hole 1 3/4" deep. Use a rotary hammer drill with a long sharp spline bit. As a guide for the proper insertion depth use a piece of masking tape to mark a point 1 3/4" from the tip of bit.
NOTE: Replace drill bit often, dull bit can cause misshapen or undersized holes.
2. Insert brass anchor shell into hole and tamp lightly with tamp tool to ensure a tight fit.
3. Screw brass insert into casing.

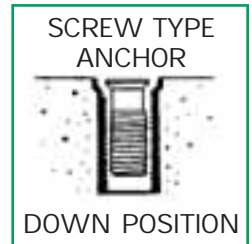
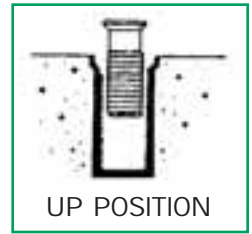

Anchor Installation Brick or Pavers

The anchor in pipe method should be used for the best installation in these surfaces. Use 1 brass anchor and 1 - 15" length of pipe or conduit per hole. **NOTE:** Insert the brass anchor shell into one end of the pipe and crimp so that the anchor will not fall through the pipe.

1. Using a rotary hammer drill (Hammer Off) with a 7/8" or 1" sharp spline drill bit, drill between bricks or pavers to avoid cracking them. Drill deep enough so that the insertion of the anchor/pipe assembly can go in easily.
2. Drive the assembled (Pipe/Anchor) through hole and into the ground until flush. Use a block of wood over end of pipe before driving to prevent damage to the anchor assembly.
3. Screw the brass insert in. **NOTE:** For an extra strong installation use a Rocktite type of cement to secure the pipe assembly. This will prevent leaning.

Wood Deck Anchor Flange Installation

1. Counter sink a 1 1/2" diameter hole 1/8" deep using a wood self boring bit.
2. Drill a 3/4" diameter hole using the wood deck pilot hole as a guide, approximately 2-2 1/4" deep.
3. Insert the anchor flange into the hole and tap until the flange is flush with the top of the deck.
4. Secure the flange with screws.
5. Screw in the brass insert as usual. **NOTE:** Use our plastic spring protectors on the springs to protect the deck from gouging and marring.

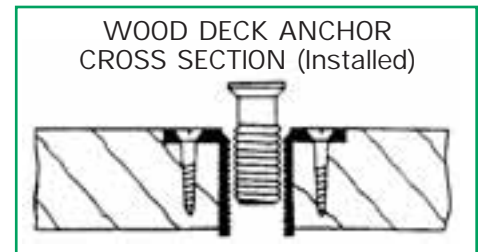
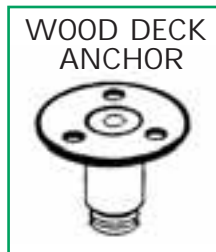

SPRING INSTALLATION

Attaching Springs To Straps

Lacing straps around our unique stainless steel spring/buckle combination cuts installation time. This system also allows for easy re-adjustment of springs and ensures the proper compression of the springs as well.

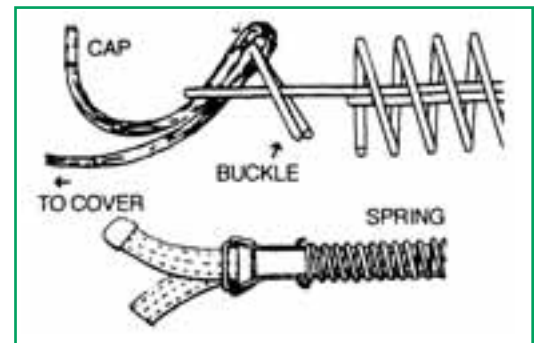

Installing Springs On Anchors

1. Insert the installation rod through the retaining ring on the end of the spring.
2. Place the elongated semi-circular end of rod behind the raised anchor. Pull the rod handle away from the edge of the cover, until the retaining ring slides over the anchor.

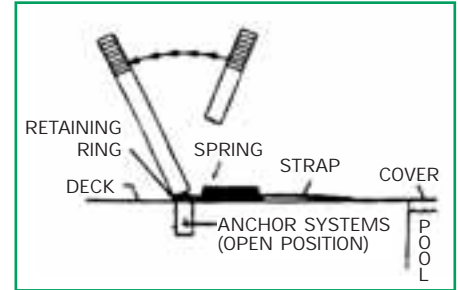
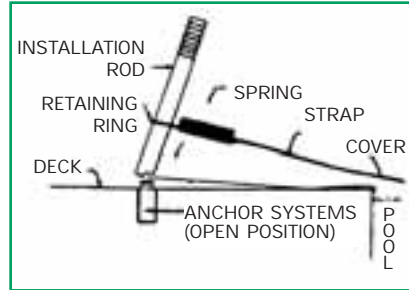

3. Rotate the rod until it is free from the anchor. **NOTE:** Pressing down with your shoe will assist in sliding the retaining ring off the rod.

Removal Of Springs From Anchors

1. Insert the installation rod over the anchor with the elongated end facing the cover.
2. Press down and rotate the rod approximately 180 degrees. The elongated end of the rod will now be between the anchor and the retaining ring.
3. Slightly tilt the rod toward the pool until the spring slides off the anchor.

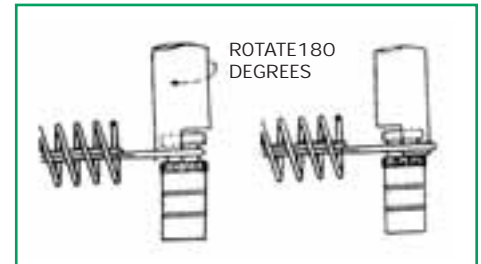

CAUTION: BE VERY CAREFUL, SPRINGS ARE UNDER A GREAT DEAL OF TENSION!

RAISED WALL INSTALLATION

A raised wall installation is to be used when there is no decking in an area around the pool (i.e. waterfalls, raised spas, etc). This area must always be installed first before any other section of the cover. We recommend that the wall anchors be installed no more than 18" apart as a maximum.

Eyebolt and Snaohook Installation

1. Locate the anchor positions.
2. Drill a pilot hole, then continue with a 1/2" masonry bit to a depth of 1 5/8" max. in the wall or raised obstruction.
3. Insert the masonry wall anchor and tamp till flush with the surface area. (Use a wall tamp tool).
4. Screw the eyebolt into the wall anchor.
5. Run a 3/16" stainless or vinyl coated cable (not supplied) through the eyebolts and secure with a turnbuckle for tensioning at both ends.
6. Fasten the snaohooks to the cable.

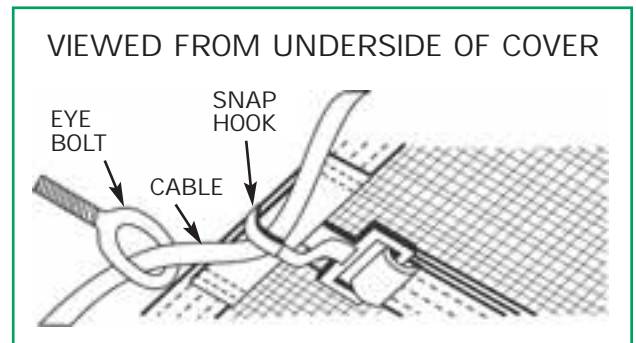

NOTE:To ensure a tight closure on a wide variety of obstructions such as raised walls, waterfalls, dive rocks, raised spas etc., The Cover Company, Inc. uses a tough, soft, floating closed cell foam encased in a high tensile fabric casing which is abrasion resistant and waterproof which sewn onto the cover's edge.

UP & OVER INSTALLATION

The Up & Over treatment (for a pair of steps, up and down) consists of four up & over brackets, four extra anchors (eight total), two extra springs (four total), and two triangular flaps sewn to the cover. Each flap is slightly longer than the step is high. This will require drilling four extra holes per pair of steps.

1. Install the cover as usual, making sure that the flaps at the up & over line up with the actual steps in the deck. Secure and adjust all straps except the ones on the ends of the triangular flaps.

2. Once the cover is installed, hold each flap out and down to the lower level of the step and mark the corner of the flap on the deck. This will be one anchor location. Measure back from that point at least 14 inches more and mark the second anchor.

3. Install anchors at these points. The anchor closer to the pool will use a bracket and the other will use a spring. The strap will run through the bracket and back to the spring (see drawing below). **Do not** put a lot of tension on this strap. This spring only needs enough tension to hold down the flap, it does not need to support any weight of the cover.

4. At the first (or second) strap past the step, at the thin end of the flap, you should have one spring and anchor installed as usual. The edge of the cover will probably be lifted off the ground here. If so, install an anchor and bracket about an inch from the cover edge and run the strap through it (see above). If you have a strap somewhere in the middle of the triangular flap, install an anchor and bracket at that strap also. Be sure to screw down all anchors with brackets to hold the bracket against the deck. Repeat for the other step in the pair.

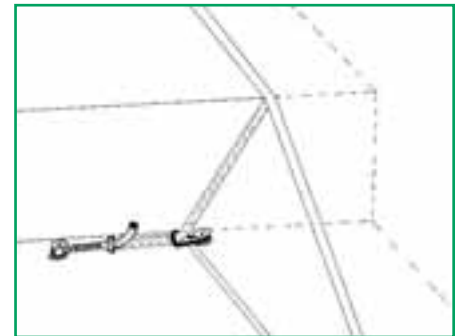
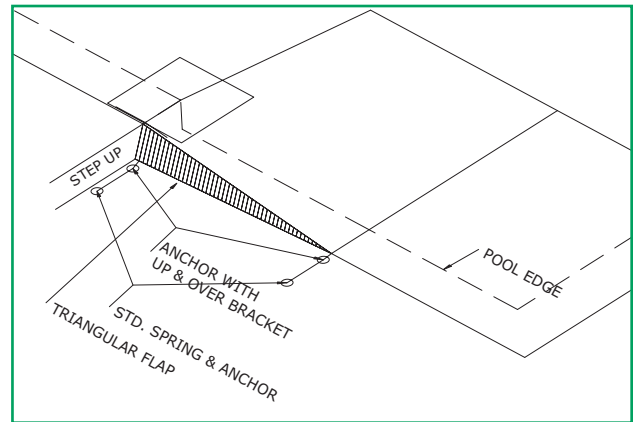

FIBERGLASS RAISED SPA INSTALLATION

The triangular flap method will not work on a raised fiberglass spa or other applications where the overlap of the cover extends past the back edge of the raised area. In these cases, we suggest using brackets along with a foam block to fill any openings. This treatment includes a foam block, two up & over brackets, and two extra brass anchors.

1. Install cover as usual, including all straps around the spa.

2. At the first strap beyond the raised area (or second if the first is too close to the spa), pull the edge of the cover to the ground (adjusting some springs if necessary) and mark where the edge of the cover meets the deck.

3. Install an anchor at this mark, and another 14-18 inches back from it, following the direction of the strap.

4. Install a bracket on the anchor at the cover's edge and run the strap through it, back to the spring and anchor behind it. See bracket and spring detail. When tight, this will leave a triangular gap. This spring can be tightened to normal tension.

5. Cut the foam block into a triangle slightly larger than the opening. Loosen the cover and install the foam block and then re-tighten the cover. The tension of the cover will hold the foam in place. This will close all openings to the water. Repeat for the other side of the spa.

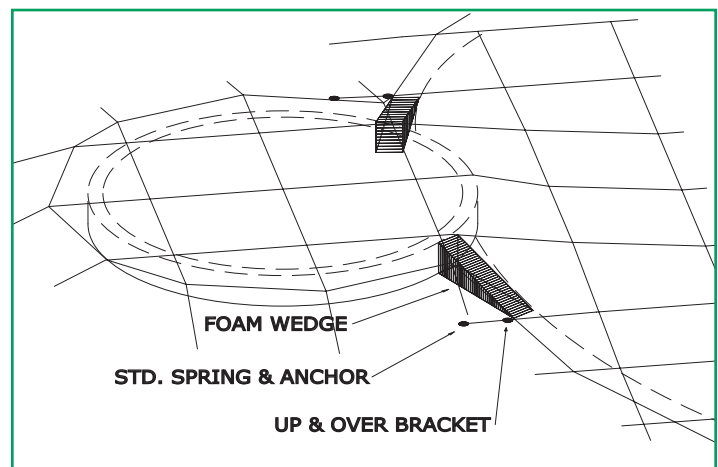

INSTALLATION FOR ROUGH/SHARP COPING OR DECKING AND WINDY POOL SITES

When covering a pool with sharp edges or coping, a pad needs to be installed over the edge of the pool between the cover and the sharp edge. This is also necessary in windy pool sites so that the wind will not get under the cover and cause friction between the fabric and the coping surface. Neither of these potential wear problems are covered by your warranty.

Padding material can be ordered from The Cover Company, Inc. or use an appropriate colorfast outdoor carpeting. Padding will extend the service life of your pool cover and bring many years of enjoyment and safety.

GUIDELINES & ADJUSTMENT FOR SOLID COVERS

Failure to follow these simple installation guidelines can result in serious injury and/or damage to your pool! To meet warranty conditions, solid covers must be tested upon initial installation for proper drainage. Please follow these easy-to-do guidelines:

1. After initial installation, flood the cover with water using a garden hose. If the cover has been tensioned properly, all the water will flow towards the drain panels(s) or pump panels. The water will slowly drain; if a pump is in use, run the pump to remove the water. After draining, the cover should return to its original taut condition.
2. If the water does not drain properly, cover re-adjustment is required. Additional tension in the panels' straps and springs where water remains collected is necessary (see installation guide for adjustment procedures and diagrams listed under SPRING INSTALLATION section for additional information).
3. Retest and re-adjust, if necessary. If water still "puddles" in areas on the cover, strap tension can be slightly reduced on only the straps securing the drain panel(s) and/or pump. This is done to create a "funnel-effect" where surface water will gravitate to the drain panel(s) or pump for proper drainage. Then retest! Follow steps 1-3 until the water drains correctly.
4. With each pool closing re-adjustments may be required as necessary. Initially, annually or whenever a "puddle" is not draining. Water accumulation on the top of the cover will shorten the service life.

IMPORTANT

IN NO INSTANCE SHOULD THERE BE AN OPENING LARGE ENOUGH TO PERMIT A 4 1/2" TEST OBJECT INTO THE POOL. SHOULD A INSTALLATION LIKE THIS OCCUR, THE COVER WILL NOT BE CLASSIFIED AS A SAFETY COVER, ACCORDING TO ASTM STANDARDS.

CARE & MAINTENANCE OF YOUR COVERLON SAFETY COVER

Following these simple care procedures will ensure the longest life and safest use of your low maintenance COVERLON cover.

While In Use

Although your COVERLON cover will support the weight of several adults, we do not recommend walking on it. Your cover is intended for safety and should only be walked on in an emergency.

STAY OFF THE COVER!

INSTALL YOUR COVER TIGHTLY. At the FIRST installation, the springs should be compressed about 90%. The tension will decrease slightly with time, without adjustment. The springs should always be compressed at least 50% and the cover should resemble a trampoline with little or no sagging. Should the cover start to sag or the springs expand to be less than 50% compressed, tighten the straps.

SOLID COVER ADJUSTMENT. "Funnel effect" tension must be maintained to allow water to drain towards the drain panel(s). maximum spring compression (90%) should be maintained through out the majority of the cover, with the exception of the drain panel springs; these should be maintained at minimum spring tension (50%). (See page 5 for details)

SNOW SUPPORT. Water should NOT be drained from your pool before installing your cover. The water helps to support any additional weight on the cover, including large snow loads. If the water level is more than 18" below the top of the pool, a snow load could put excess strain on your cover and will void your warranty. In case of a heavy snow fall, try to sweep the snow off the cover (DO NOT STAND ON THE COVER TO DO THIS) use a brush with an extendable handle. This will prevent the snow from freezing into ice. Having a large ice load on a cover may cause straps to prematurely wear down and deform springs.

REMOVAL AND STORAGE

- Hose off any debris from the cover before removing it. Use a soft brush to remove any excess debris and allow the cover to dry completely before folding and storing.
- Accordion fold the cover (fold both ends in toward the center) and put it in the storage bag. Hang the bag off the ground to keep animals (i.e. rodents) out/away from it.
- CARRY the cover to and from the pool area. Do not drag your cover. Dragging can result in tears in the material, worn areas and other damage.

HARDWARE

ANCHORS. Before installing or after removing the cover, remove the deck anchors and vacuum out all of the casings to remove any debris. When the cover is not in use, close the anchors so that they are flush with the deck and out of the way.

SPRINGS. Our springs are designed for easy installation. Excessive weight (from heavy snow/ice) that is on the cover for an extended period of time will cause the springs to lose their shape. Since the springs are not covered under the warranty please try to safely remove all excess weight as soon as possible.

CHEMICAL TREATMENT

Your COVERLON cover will keep out debris, but to keep the water clear you must maintain the proper levels of chlorine and algaecide, even when the pool is not in use.

- When closing your pool, use a winterizing chemical kit, which should include algaecide and floating canisters (of Chlorine or Bromine) appropriate for your pool's water capacity.
- A month or so before opening your pool, or when your average daily temperature reaches 60° F, add additional algaecide.
- Automatic cleaners may be used underneath your COVERLON cover.

12 YEAR LIMITED WARRANTY

To validate the warranty, the warranty card has to be completed and returned to The Cover Company, Inc. within 10 days of installation. For future reference, please keep a copy of the original invoice, and the warranty number.

SAFETY

WARNING: DO NOT TAKE UNNECESSARY RISKS, DO NOT WALK ON THE COVER.

NOTE: Covers must meet safety standards as set by ASTM to be warranted as a safety cover.

THE WARRANTY

The COVERLON safety pool cover is warranted to the original purchaser to be free from manufacturing defects in workmanship under normal usage, assuming the proper installation and maintenance. The cover will be pro-rated for 12 years after the purchase date from The Cover Company, Inc. As per The Cover Company's discretion, we will replace or repair any part of a new cover that has a manufacturing defect, for a period of one year from the date of purchase, free of cost. After the first year, any workmanship performed (repairs or replacement), will be charged a pro-rated cost of current retail prices.

EXCLUSIONS

This warranty does NOT cover and we expressly renounce and disclaim any liability for the following:

- If the water level falls below 18" from the top of the pool during the time the cover is in use. This is especially important during the snow season, as the extra weight from the snow/ice may cause damage to the cover and hardware.
- The cover has been subject to misuse, loosening (not being drum tight), neglect, or abuse. Premature wear and/or damage to the strapping or perimeter may result.
- The cover is not installed as per the directions of The Cover Company's Installation Guide.
- If the cover is used for a pool other than the original installation or to cover a pool other than the cover was intended to cover, i.e. a large rectangle over a free form pool.
- Burn holes from cigarettes or from the effluent of fireplaces.
- Rips and tears caused by acts of nature are not covered, (i.e. animals walking on the cover or a tree limb falling on the cover).
- Hardware (i.e. springs) that deform from excessive weight on the cover (i.e. heavy snow or ice).
- Any consequential damage to you or your pool/property resulting from the cover (i.e. damage done to the coping). Your chances of damages increase dramatically when the water level falls below 18" from the top of the pool.

WARRANTY CLAIM PROCEDURE

1. Written notice must be sent within 10 days of the defect(s) appearance. Mail to:

THE COVER COMPANY, INC.

19 Readington Road

Branchburg, NJ 08876

2. This must include pictures of the defective area(s), a copy of the original invoice and the warranty number.

3. We will then evaluate the claim and advise you to clean and return the cover to us so that we may determine the cause of failure. This must be done between January 1st and June 30th.

4. If we request the cover to be returned, the freight is to be pre-paid by you. On inspection, if the defect is covered by the warranty, we will then pay the freight charges for both ways and repair or replace the cover at our discretion. If not, the cover will be returned freight collect.

We will not be liable for any incidental or consequential damages resulting from any defects in workmanship or material(s), including but not limited to: cost of labor, chemicals or any damages that may occur there from. Some states do not allow the exclusions or limitations of incidental or consequential damages, therefore foregoing limitation or exclusion may not apply.

This warranty is in lieu of any other warranties, expressed or implied, and of all other obligations or liabilities on our part, and we neither assume nor authorize any person to assume for us any other obligation and liability in connection with the sale of this product. No warranty is applicable if the cover has been subject to misuse, alteration, neglect, abuse, or any accidents, i.e. if the water falls below 18 inches from the top of the pool.

AVOID DROWNING RISKS

- It is very important to keep the cover drum tight.
- Extremes of weather will void the warranty.
- Stay off the cover - do not walk on the cover.
- Keep children away. Children or objects cannot be seen under the cover.
- Do not enter the pool with the cover on or partially removed - entrapment is possible.
- Improperly or partially secured covers are unsafe and a hazard.
- Failure to follow all instructions may result in injury or drowning.
- Do not place anything on the cover.
- Inspect the cover periodically for wear or deterioration. Worn areas are a hazard.

It is your responsibility to make sure that the cover meets all safety requirements.

SAFETY IS EVERYONE'S CONCERN



THE COVER COMPANY, INC.

19 Readington Road, Branchburg, New Jersey 08876

908.707.1122 • Fax 908.707.1575

www.coverlon.com